



TL-3424 USER`S MANUAL



TL elektronik
Airport, Building 125, Hradec Kralove
503 41, Czech Republic

© Copyright 2003-2006
TL elektronik
All Rights Reserved

Except as expressly provided below, no part of this manual may be downloaded, transmitted, copied, reproduced, disseminated or stored in any storage medium, for any purpose without the express prior written consent of the TL elektronik company. Address your questions about the technical information to TL elektronik. Other information about sale, distribution should be directed to our exclusive distributors (see World Distributor list on our website).

Producer's address:
TL elektronik Inc.
Airport, Building 125,
503 41 Hradec Kralove, Czech Republic
Fax: +420 49 548 23 94 E-mail: info@tl-elektronic.com
Web Site Address: www.tl-elektronic.com

Please, send your e-mail address to customer@tl-elektronic.com to receive the latest information about software upgrade.

*Send your ideas to innovation@tl-elektronic.com.
We will evaluate your suggestion and provide an update.*

Record of revision

Revision	Revision date	Description	ECO#	Insertion date	By
A	1/6/03	Initial Release	---		
B	1/7/04	Language correction	0001		

Windows is registered trademark of Microsoft Corporation.
All trademarks and registered trademarks are acknowledged.
ScheckK® is registered trademark of TL elektronik.
iFamily® is registered trademark of TL elektronik.
sModern® is registered trademark of TL elektronik.
All information in this User's manual is subject to change without prior notice.

TABLE OF CONTENTS

1. GENERAL DESCRIPTION	
1.1. Introduction.....	1-1
1.2. Instrument Description.....	1-1
1.3. Technical Specifications.....	1-2
1.4. Limited Conditions.....	1-3
1.5. Limited Warranty.....	1-3
1.6. Limited Operation.....	1-3
2. INSTALLATION	
2.1. Introduction.....	2-1
2.2. Rack Consideration.....	2-1
2.3. Installation into Panel.....	2-1
2.5. Instrument Dimensions.....	2-2
2.6. Instrument Dimensions - Version SAS.....	2-3
3. SYSTEM INTERCONNECT	
3.1. Pin Function List.....	3-1
3.2. TL-3424 Interconnects.....	3-2
3.3. TL-3424 Connector Location.....	3-3
3.4. TL-3424 Connector and Pressure Hose Fittings ^c Location - Version SAS.....	3-4
4. NAV-MENU DESCRIPTION	
4.1. How to Control Instrument via NAV-MENU.....	4-1
5. INSTRUMENT SETUP	
5.1. First Instrument Turn-on.....	4-1
5.2. Main Set-up Functions ^c Description.....	5-1
5.3. How to Select Warning and Alarm Limits of Acceleration.....	5-2
5.4. How to Control Recording into Memory.....	5-2
5.5. Speed for Activation of Recording into Memory.....	5-2
5.6. Recording with Timer.....	5-3
5.7. External Signalization Unit.....	5-3
5.8. Light Signalization.....	5-3
5.9. User Button.....	5-4
5.10. Delete Long-term Memory of Acceleration.....	5-4
5.11. iFamily® and Other Connecting Devices.....	5-4
6. OPERATION MANUAL	
6.1. Left Menu Description.....	6-1
6.2. Right Menu Description.....	6-2
6.3. How to Change Configuration.....	6-3
6.4. Displaying Maximum Acceleration	6-3
6.5. Displaying Time of Exceeding Acceleration.....	6-3
6.6. Measuring Value out of Range.....	6-4
6.7. Control and Marker External Button.....	6-4
6.8. Storing into Memory Paused.....	6-4
6.9. Storing into Memory Running.....	6-5
6.10. Storing into Memory with Timer.....	6-5
6.11. How to Select Timer.....	6-5
7. SchecK® DESCRIPTION	
7.1. Method of SchecK® for Storing into Memory.....	7-1

1. GENERAL DESCRIPTION

1.1. INTRODUCTION

This manual describes the physical, mechanical and electrical features and functions of the TL-3424 Accelerometer.

1.2. INSTRUMENT DESCRIPTION

The TL-3424 is complete weight acceleration management. The instrument incorporates a high-precision sensor for measuring acceleration in the vertical axis. The SAS version also incorporates a sensor for measuring the indicated airspeed, which enables the activation of memory recording. Both versions enable to utilize an undercarriage scanner that can also activate memory recording.

The Control and Marker Button serves for storing marks in the memory records. Pressing the button enters marks into the memory records and enables the user manual control of the memory records.

The TL-3424 incorporates a 20,000 line long-term memory and SchecK® memory (see page 7-1) for storing the measured values at 0.1 to 60 second sample rate.

The TL-3424 checks all measured values at two levels - for a warning and an alarm limit signalization.

When the alarm warning has been activated, the instrument will display a Service message after the next turn-on of the instrument to inform the user of the exceeded acceleration.

The User Button can be programmed in the main set-up for the quick display of any measured value or for the quick switch to another function. It is possible to download the measured values from the instrument via the serial cable RS-232c into your PC.

1.3. TECHNICAL SPECIFICATIONS

The producer guarantees all stated technical parameters only when the instrument is installed by an authorized service or an aircraft manufacturer.

1.3.1 Physical Characteristics

Width	71mm (2.795 inches)
Height	67mm (2.637 inches)
Depth	92mm (3.622 inches) including connectors with cover
Panel hole	57mm (2.244 inches) diameter
TL-3424 Weight	0.25 kg (0.55 lbs) / version SAS 0.30 kg (0.66 lbs)
TL-3424 Harness	0.05 kg (0.11 lbs)

1.3.2 General Specifications

Operating Temperature Range	-20°C to +70°C
Humidity	95% non-condensing
Altitude Range	4600 meters max.
Power Range	10.0 to 32.0 Volts
Max. Signalization	30 Volts, 1 Ampere
Power Consumption	0.15 Ampere @ 14 VDC without gear sensor
Backlight Consumption	0.08 Ampere max when ext. power is used
Vibration	5 to 500 Hz
Show Rate (LCD Refresh)	0.5 second

1.3.3 Long-term Memory and Communication

Storing Rate	0.1 to 60 seconds user selectable
Memory Capacity	Scheck® method
Stored Values	Acceleration, (Air speed - version SAS only)
Data Saved Endurance	30 years
Rolling Memory life-time	50 000 hours @ 0.1 second storing rate
Communication	RS-232c
Communication Speed	38400 bps

1.3.4 Landing Gear Switch

Input Parameter	Positive pulse 8 to 32 Volts
Type of Switch	Inductive sensor of PNP type or standard gear switch connected between pins 9 and 5

1.3.5 Instrument Measured Range / Resolution

Acceleration	+15.0g to -15.0g / 0.1g
Air speed (only SAS version)	20 to 350 km/h / 5 km (10.8 knots to 189 knots / 2.7 knots) Absolute maximum speed 500 km/h (270 knots)

1.4. LIMITED CONDITIONS

1.5. LIMITED WARRANTY

The TL elektronik company warrants this product to be free from defects in materials and manufacture for three years from the date of purchase. TL elektronik will, at its sole option, repair or replace any components that fail in normal use. Such repairs or replacement will be made at no charge to the customer for parts or labour. The customer is, however, responsible for any transportation costs. This warranty does not cover failures due to abuse, misuse, accident or unauthorized alteration or repairs.

THE WARRANTIES AND REMEDIES CONTAINED HEREIN ARE EXCLUSIVE AND IN LIEU OF ALL OTHER WARRANTIES EXPRESS OR IMPLIED OR STATUTORY, INCLUDING ANY LIABILITY ARISING UNDER ANY WARRANTY OF ENCHANT ABILITY OR FITNESS FOR A PARTICULAR PURPOSE, STATUTORY OR OTHERWISE. THIS WARRANTY GIVES YOU SPECIFIC LEGAL RIGHTS, WHICH MAY VARY FROM STATE TO STATE.

IN NO EVENT SHALL TL ELEKTRONIC BE LIABLE FOR ANY INCIDENTAL, SPECIAL, INDIRECT OR CONSEQUENTIAL DAMAGES, WHETHER RESULTING FROM THE USE, MISUSE, OR INABILITY TO USE THIS PRODUCT OR FROM DEFECTS IN THE PRODUCT. SOME STATES DO NOT ALLOW THE EXCLUSION OF INCIDENTAL OR CONSEQUENTIAL DAMAGES, SO THE ABOVE LIMITATIONS MAY NOT APPLY TO YOU.

To obtain warranty service, call the TL elektronik Customer Service (+420 49 548 23 92) for a returned merchandise tracking number. The unit should be securely packaged with the tracking number clearly marked on the outside of the package and sent freight prepaid and insured to a TL elektronik warranty service station. A copy of the original sales receipt is required as the proof of purchase for warranty repairs. TL elektronik retains the exclusive right to repair or replace the unit or software or offer a full refund of the purchase price at its sole discretion.

SUCH REMEDY SHALL BE YOUR SOLE AND EXCLUSIVE REMEDY FOR ANY BREACH OF WARRANTY.

1.6. LIMITED OPERATION

This product is not TSO approved as a flight instrument, therefore, the manufacturer will not be held responsible for any damage caused by its use.

All maximum or minimum acceleration limits set either by the manufactures or by the user cannot be used for flight operations on or beyond the boarder of the aircraft operational acceleration.

2. INSTALLATION

2.1 INTRODUCTION

Careful planning and consideration of the suggestions in this section are required to achieve the desired performance and reliability from the TL-3424.

2.2 RACK CONSIDERATION

Plan a location that gives the pilot complete and comfortable access to the entire keypad and is plainly visible from the pilot's perspective. Check that there is adequate depth for the rack in the instrument panel. A place away from heating vents or other sources of heat generation is optimal.

2.3 INSTALLATION INTO PANEL

⚠ Connect the cables into the connector and use the connector cover. Secure the incoming leads to prevent their effect on the connector in the vertical direction.

⚠ The instrument must be installed parallel with the aircraft axis and in a place with no vibration.

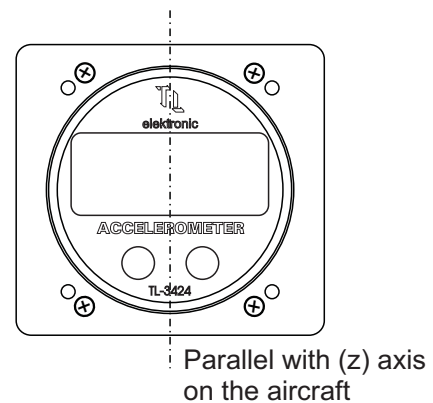
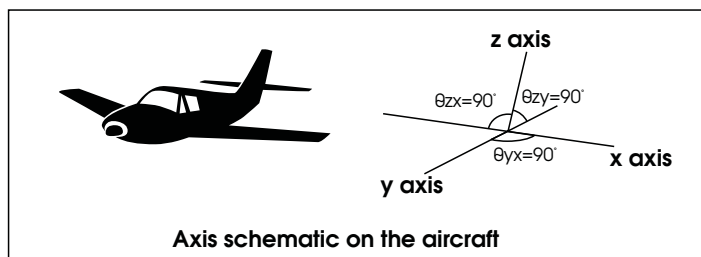

⚠ Check after the installation that the instrument shows the reading **+1.0g** on the display while the aircraft is standing on a plain surface.

Mounting Rack Dimension

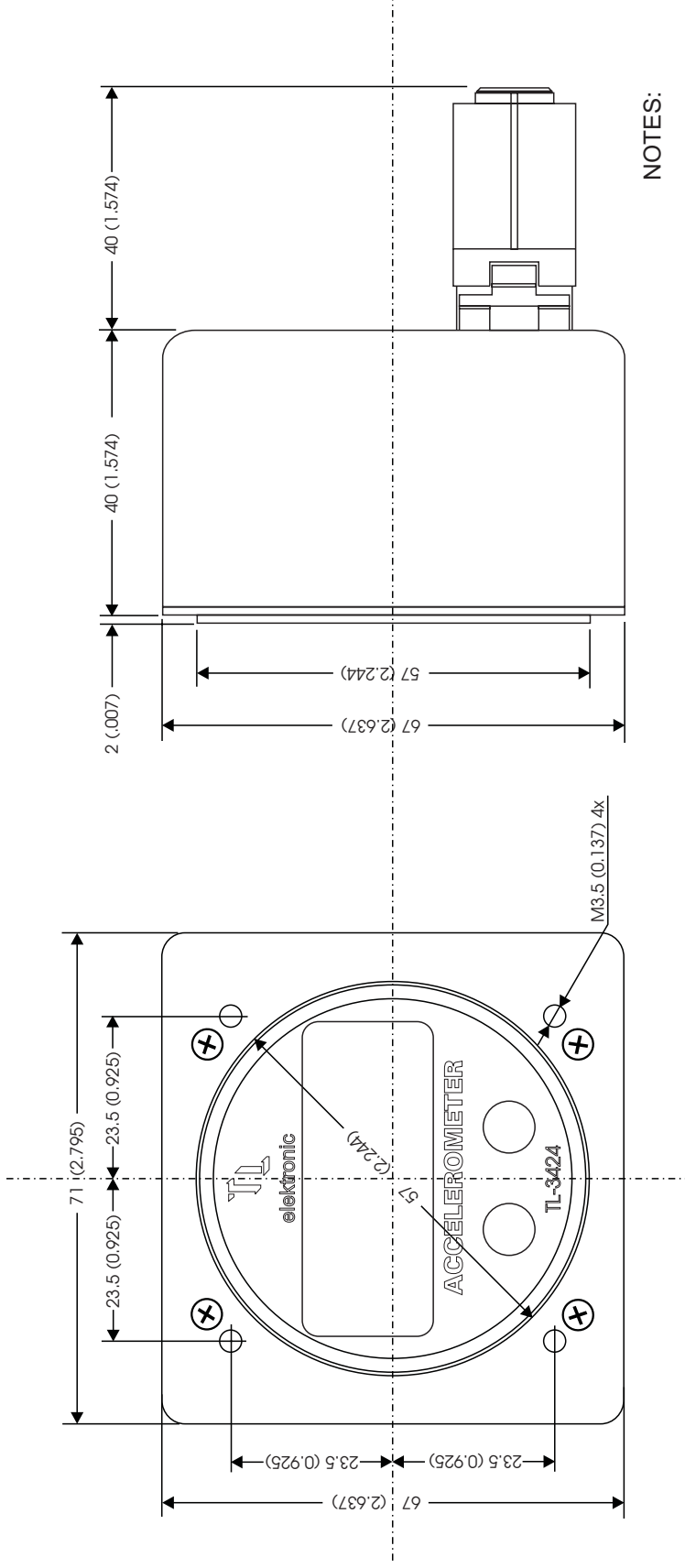

NOTES:

1. Dimension: mm (INCH)
2. Unit weight: 0.25 kg (0.55 lbs)
3. Mounting Rack & Hardware weight: 0.05 kg (0.11 lbs)

Figure 1. Rack Dimension

Mounting Rack Dimension - Version SAS with internal Air Speed Sensor

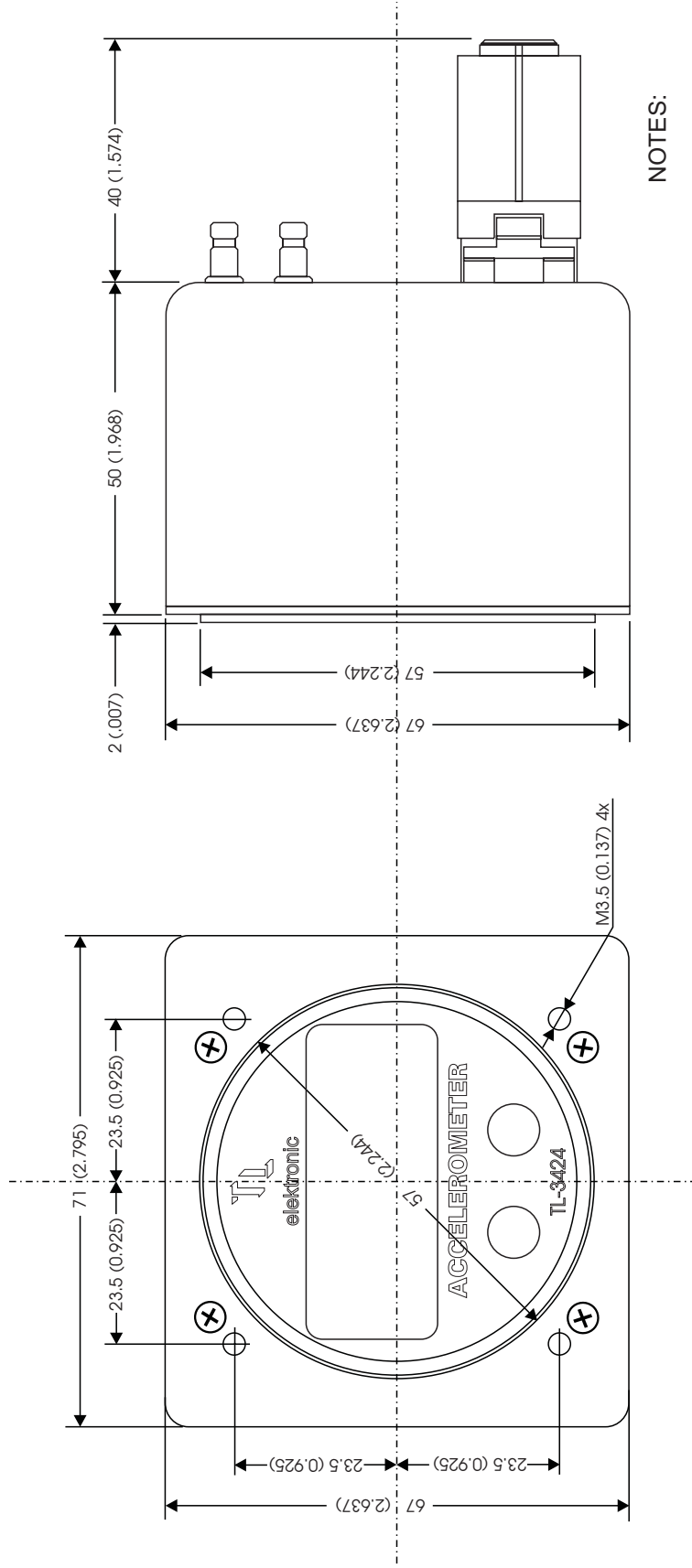

NOTES:

1. Dimension: mm (INCH)
2. Unit weight: 0.3 kg (0.66 lbs)
3. Mounting Rack & Hardware weight: 0.05 kg (0.11 lbs)

Figure 2. Rack Dimension

3.1 PIN FUNCTION LIST

Pin	Pin Name	I/O
1	Control and Marker button	In
2	Ground for Control and Marker button	- -
3	External status light	Out
4	Ground for external status light	- -
5	Output from landing gear switch (pick-up sensor)	In
6	Ground for landing gear switch (pick-up sensor)	- -
7	Aircraft power	In
8	Aircraft ground	- -
9	Power +12 Volts for landing gear switch (pick-up sensor)	Out
10	Do not connect!	- -
11	Input for backlight	In
12	Internal source for backlight	Out
13	Do not connect!	- -
14	Do not connect!	- -
15	Input for User button	In
16	Ground for User button input	- -
17	Do not connect!	- -
18	Do not connect!	- -
19	iFamily® communication ISCL	I/O
20	iFamily® communication ISDA	I/O
21	Signalization unit	Out
22	Ground for PC communication (RS-232)	- -
23	RXD from PC (RS-232)	In
24	TXD to PC (RS-232)	Out

Accessories Interconnect

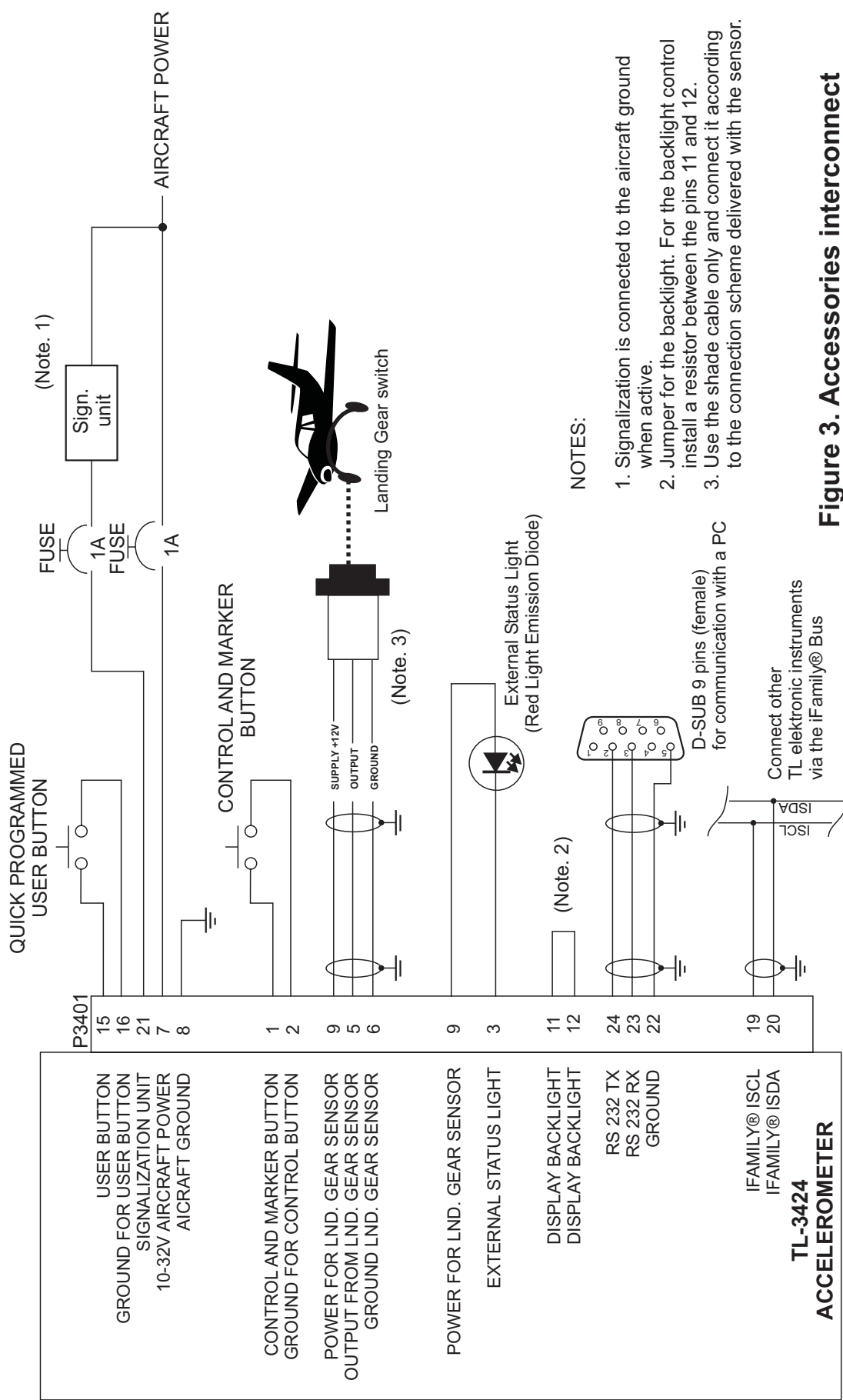
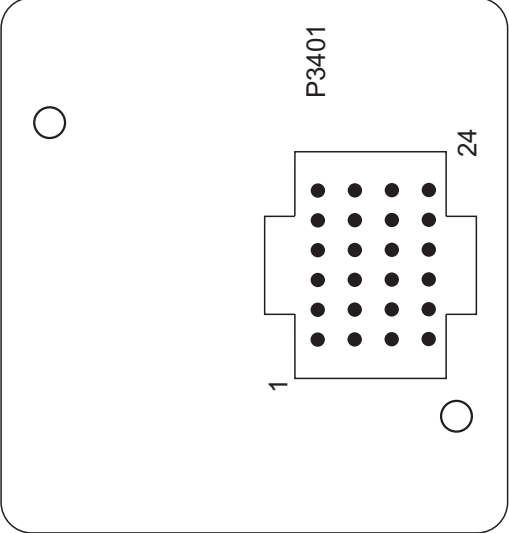

Figure 3. Accessories interconnect

Rear view of connector plate



NOTES:

- 1. Secure the incoming leads to prevent their effect on the connector in the vertical direction.

Figure 4. Connectors locate

Rear view of connector plate and pressure fitting - version SAS with Air Pressure Sensor

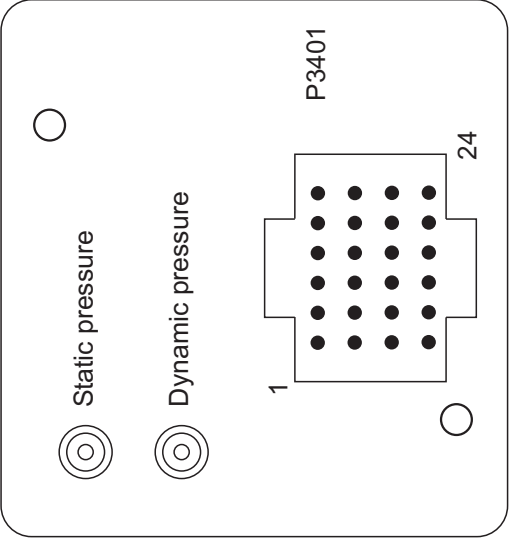

NOTES:

- 1. Secure the incoming leads to prevent their effect on the connector in the vertical direction.
- 2. Secure both hoses of the static and the complete (pitot) pressure. Any leakage or untightness could cause incorrect indications of other instruments.

Figure 5. Connectors locate

4. NAV-MENU DESCRIPTION

4.1 How to Control Instrument via NAV-MENU

There are black labels on the display. Each is affiliated to the left and the right button. Before pressing a button, read the information on the label. Its functions are different in every menu.

The left label is for the Left button.

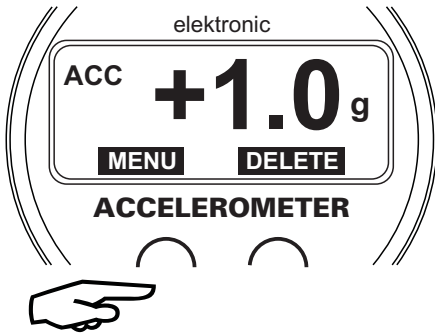

The right label is for the Right button.

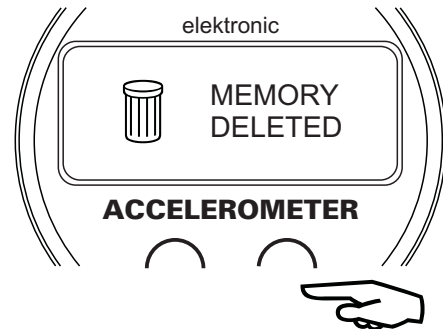

To store a value into the memory, press both buttons simultaneously. Release buttons when the setting arrows vanish.

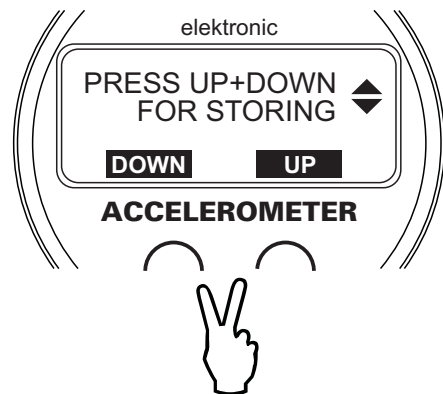

5 INSTRUMENT SETUP

5.1 First Instrument Turn-on

Before the Accelerometer starts to indicate you must do the basic setting of language, contrast, limits, etc. After the first turn-on of the instrument, the „FIRST SETUP“ message will show on the display. This set-up must be completed to continue.

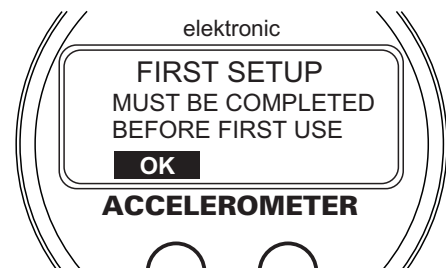

5.2 Main Set-up Functions' Description

The table of the instrument configuration steps is shown below (Initial - firmware version 1.0).

0	LANGUAGE	Select your language for communication with the instrument.
1	DISPLAY CONTRAST	Select contrast of the display.
2	PASSWORD	Enter your password.
3	WARNING MAX	Set the warning limit for the maximum acceleration.
4	WARNING MIN	Set the warning limit for the minimum acceleration.
5	ALARM MAX	Set the alarm limit for the maximum acceleration.
6	ALARM MIN	Set the alarm limit for the minimum acceleration.
7	AIR SPEED UNIT (only version SAS)	Select your local unit for air speed.
8	REC. ACTIVATE (SPEED is shown only in version SAS)	Select the mode for the activation of memory recording. AUTO = after power supply, MANUAL = manual control, LAND = landing switch, SPEED = over speed .
9	REC. ACT. SPEED (only version SAS and when SPEED is set)	Set the air speed that activates memory recording. Note that the instrument hysteresis is +/- 3 km/h. That means that when 100 km/h is preset, the instrument starts recording at 103 km/h and stops at 97 km/h.
10	REC. TIMER	Enable or disable the timer that will show whenever recording into the memory is required.
11	ALARM MODE	Select the mode for the external signalization. OFF = signalization disabled. EXCEEDED = signalization when the acceleration is exceeded + 1 second.
12	LIGHT MODE	Select the mode for the light signalization. OFF = signalization disabled, WHEN RECORDING = light only when recording acceleration into the memory, WHEN ALARM = light only when acceleration is exceeded.
13	USER BUTTON	Program your button to these functions: SHOW MIN / MAX = shows the minimum and maximum acceleration when the button is pressed, DELETE MIN / MAX = deletes the minimum and maximum acceleration when the button is pressed.
14	VOICE WARNING	Enable or disable voice warning into your headphones. (Only with use of our Intercom TL-2424 or Voice Module)
15	DELETE MEMORY	Delete the long-term minimum and maximum acceleration.
16	INST. ON-LINE	Check the connected instruments from the TL elektronik iFamily® that are On-Line.



All information on this page is subject to change without prior notice. Download the latest version of the manual from www.tl-elektronic.com and compare with you version of firmware.

5.3 How to Select Warning and Alarm Limits of Acceleration

The maximum and minimum limit values can be set at two levels in the Set-up menu. The „Warning“ message informs about the first level exceeding, the „Alarm“ message informs about exceeding the second limit and activates recording into the SchecK® drawer. You can download all exceeded values from the instrument and analyze them on your PC.

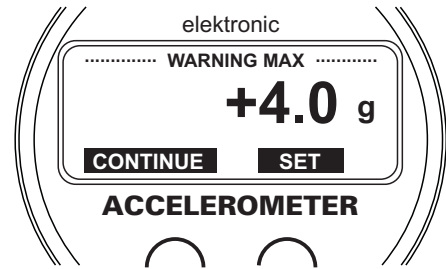

Before setting the maximum and minimum limits, check the limits of these values in the aircraft operation manual. Set the limits stated in the aircraft operation manual into the Alarm menu. The Warning limits should be lower, so that the aircraft is operated safely.

⚠ The Warning limits activate signalization informing you that the set acceleration limits have been exceeded. The Alarm limits activate signalization and, in addition, memory recording of the exceeded value, and also informs the pilot before the next flight that the set aircraft manufacturer's safety limits have been exceeded.

⚠ If memory recording is de-activated, only the Warning limit signalization is active and no data are recorded into the SchecK® memory.

5.4 How to Control Recording into Memory

Memory recording can be activated or deactivated. The reason for such control is to separate the ground and the in-flight acceleration measurement. The user can decide upon the automatic, manual (by pressing the Control/Marker button), landing gear or other scanner (recording is done only during the flight) record activation.

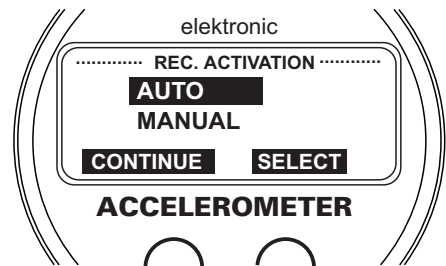

5.5 Speed for Activation of Recording into Memory

If you purchase the SAS version, which incorporates a sensor for measuring the indicated airspeed, you can set an air speed value in this menu. Set the air speed value, at which you want memory recording to be activated. This speed activation is shown only if you have selected „SPEED“ in the REC. ACTIVATION menu.

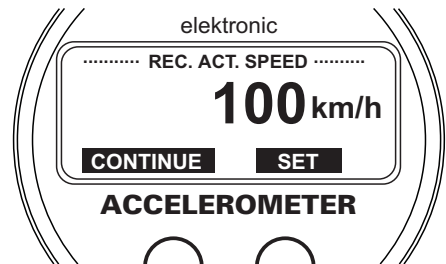

⚠ Note that the instrument hysteresis is +/- 3 km/h. That means that if the air speed of 100 km/h is set, the instrument starts recording at 103 km/h and stops at 97 km/h.

5.6 Recording with Timer

If you, for any reason, require the deactivation of recording after a certain period of time, select „ON“ in this menu. Always when recording is activated, a menu for time setting is activated. After the time lapse, recording is deactivated.

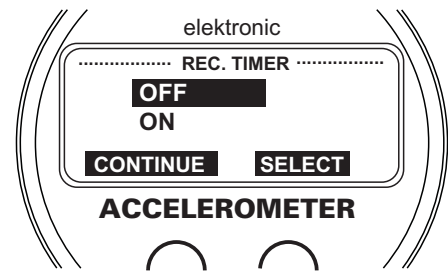

5.7 External Signalization Unit

The input no. 21 can be used for connecting a signalization unit that will inform you on exceeding the set limit value. You can decide on either an acoustic or visual (light) warning. Select „OFF“ if you do not want to be informed on limit exceeding.

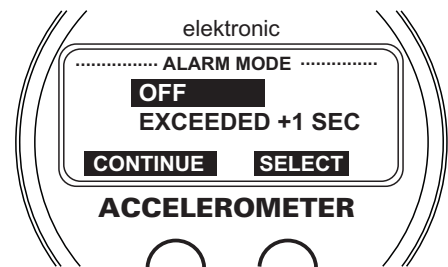

⚠ During the period of exceeding the limit, the instrument buttons are not active even when the signalization is OFF. The [- - -] symbol shows instead of actual buttons description.

5.8 Light Signalization

The input no. 3 can be used for connecting the signalization light (Led Emission Diode) that will inform you on exceeding the set limit value, the same as in 5.7, or it can also inform you on other processes, e.g. activation/deactivation of memory recording.

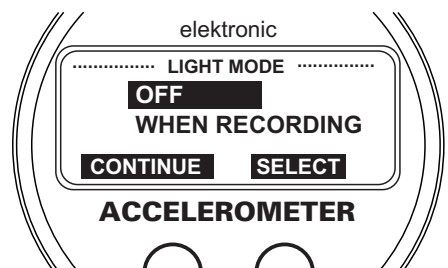

5.9 User Button

When pressed, the external User button offers you the possibility of programming to quick show or quick switch to the selected menu. After releasing the button, you will get back to the measured value indication. For example - if you have set SHOW MIN / MAX, after pressing the button you can monitor the memory of the minimum and maximum acceleration.

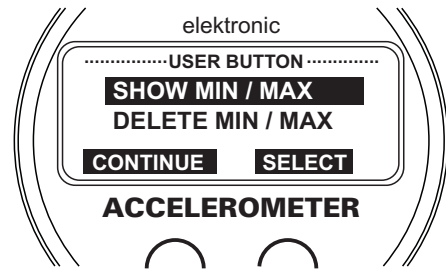

5.10 Delete Long-term Memory of Acceleration

The long-term memory of the minimum and maximum acceleration and also the time of exceeding the limits can be deleted in this menu.

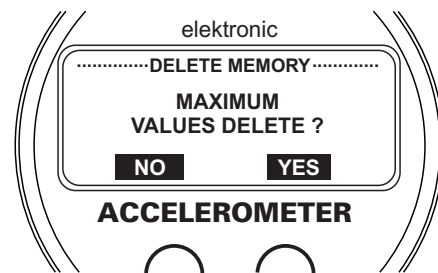

5.11 iFamily® and Other Connecting Devices

As the first of aircraft instruments, The TL-3424 enables you the connection with other instruments of the TL elektronik family in order to gain simultaneous recording of the measured values, the mass PC download of all connected instruments etc. via one cable.

If some other instruments or the GPS are connected to the reserved inputs, this menu shows each connected instrument. It also enables checking the connected instruments and devices.

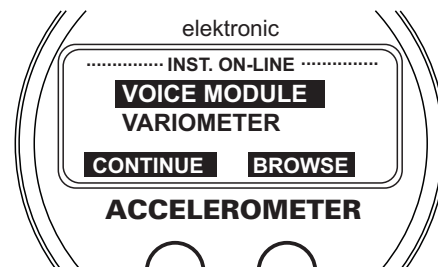

6. OPERATIONAL MANUAL

6.1. Left Menu Description

The left main menu shows the information about the minimum and maximum acceleration, exceeded time etc.

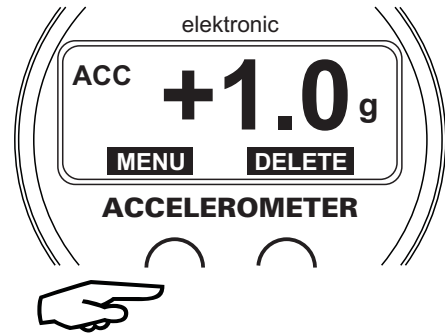

Left Menu (Initial firmware version 1.0)

First	Second	Description
MAX		Short-term memory of the maximum measured acceleration
MIN		Short-term memory of the minimum measured acceleration
	MAX(g)	Long-term memory of the maximum measured acceleration
	MIN(g)	Long-term memory of the minimum measured acceleration
	MAX(t)	Time during which the maximum acceleration was exceeded
	MIN(t)	Time during which the minimum acceleration was exceeded
	EXIT	Exit from the second menu

! All information on this page is subject to change without prior notice. Download the latest version of the manual from www.tl-elektronic.com and compare with your version of firmware.

6.1.1 Second Menu

The „OTHER“ dialog will show on the display after pressing the left button. If you press „YES“ in this dialog, the instrument will go to the second menu where you can get the information about the acceleration values from the long-term memory or about the time, during which the minimum or maximum acceleration was exceeded.

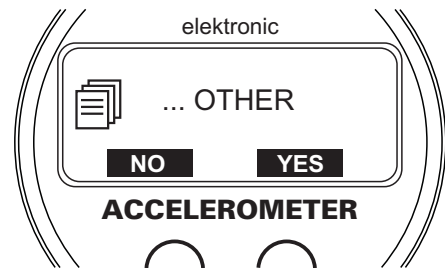

6.2 Right Menu Description

The right menu is used for the fast control.

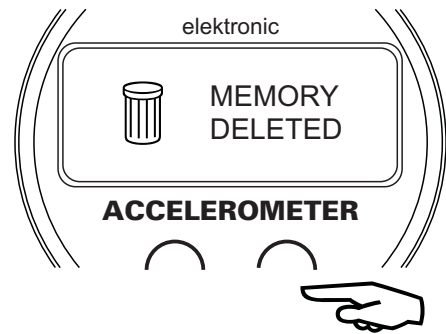

Right Menu (Initial firmware version 1.0)

First	Second	Description
DELETE		Delete the minimum and maximum acceleration from the short-term memory

⚠ All information on this page is subject to change without prior notice. Download the latest version of the manual from www.tl-elektronic.com and compare with you version of firmware.

6.2.1 Exit from Right Menu

The instrument will automatically exit the right menu after 1 second.

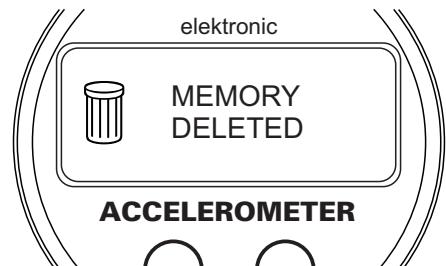

6.3 How to Change Configuration

If you want to change e.g. units or contrast, press and hold both buttons and turn the instrument on. The „Setup“ message will show on the display. Press „OK“ and go to the Instrument Setup.

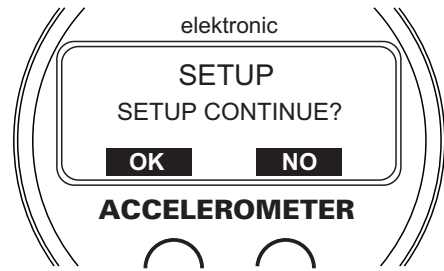

⚠ Note, that any unauthorized change of values in the Setup can cause defect of the instrument. An incorrect change of the calibration could endanger your life and the lives of your passengers.

6.4 Displaying Maximum Acceleration

The inverted symbol [M] (on the black background) shown on the right indicates that the maximum or minimum acceleration values from the long-term memory are displayed.

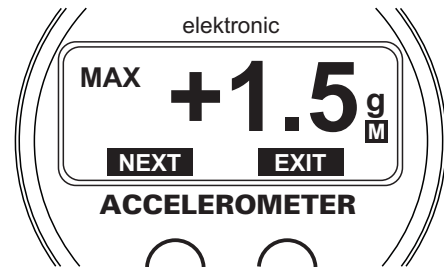

6.5 Displaying Time of Exceeding Acceleration

The inverted symbol [M] (on the black background) shown on the right indicates the time, during which the minimum or maximum acceleration was exceeded. See page 5-3 for setting Alarm limits.

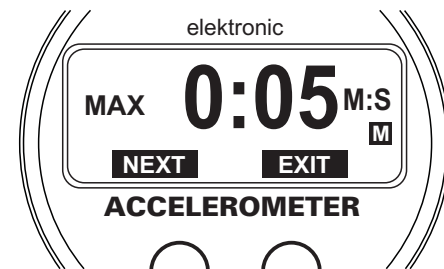

6.6 Measuring Value out of Range

When the measured acceleration of the sensor is out of range, the [----] message will show on the display.

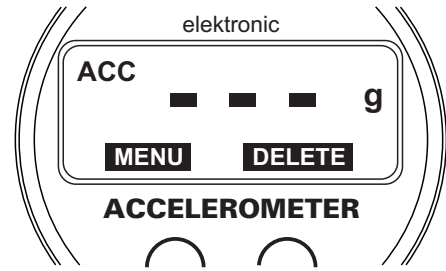

6.7 Control and Marker External Button

This datum indicates the number of a sign (Marker) that is stored into the memory. If the user needs to mark a certain part of the flight, then e.g. the number „1“ would indicate the beginning of recording. This value will always rise up by 1 if recording is activated and the Control/Marker Button is pressed again.

Five seconds after pressing the button, the instrument returns back to the acceleration measurement. If the user wants to control recording, then after pressing the Control/Marker Button and after pushing the right button next, the user can run or stop recording into the memory.

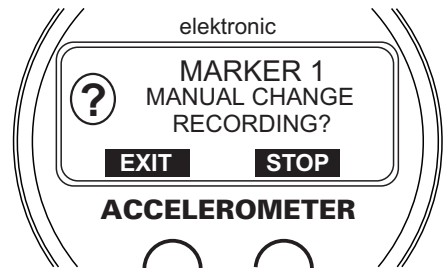

6.8 Storing into Memory Paused

The || symbol shown on the left side of the display indicates that recording was deactivated. If you want to re-activate recording, follow the instructions in the point 6.7.

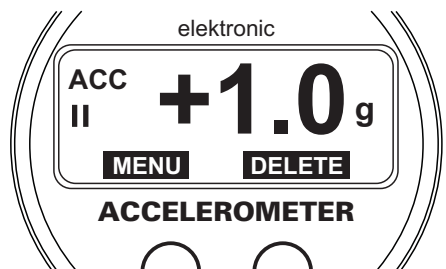

6.9 Storing into Memory Running

The  symbol shown on the left side of the display indicates that recording is activated and will be stopped when turned off by the user or the undercarriage sensor.

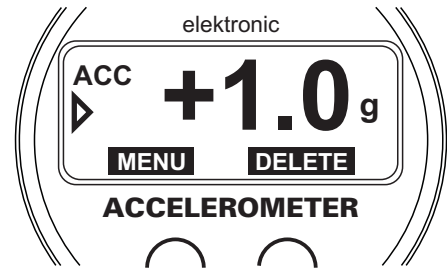

6.10 Storing into Memory with Timer

The  symbol shown on the left side of the display indicates that recording is activated and will be stopped when the set period of time expires (see 6.11).

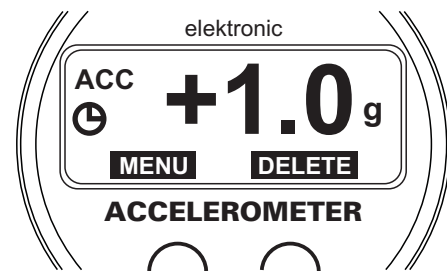

6.11 How to Set Timer

If you have selected „ON“ in REC. TIMER during the SETUP, you will be asked to set a period of time (after which the recording will stop) after every turn-on of the instrument or every activation of recording. If you do not press the „SET“ button in 2 seconds, the previously set time datum will be used for the countdown of the recording deactivation..

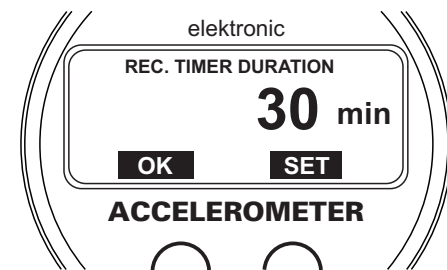

7.1 SchecK® memory description

The TL-3424 includes a 20,000 lines long-term memory and SchecK memory for storing of measured values in the 0.1 to 60 second sample rate. The measured data you can be downloaded via a standard PC serial cable RS-232 into a Laptop or Personal Computer.

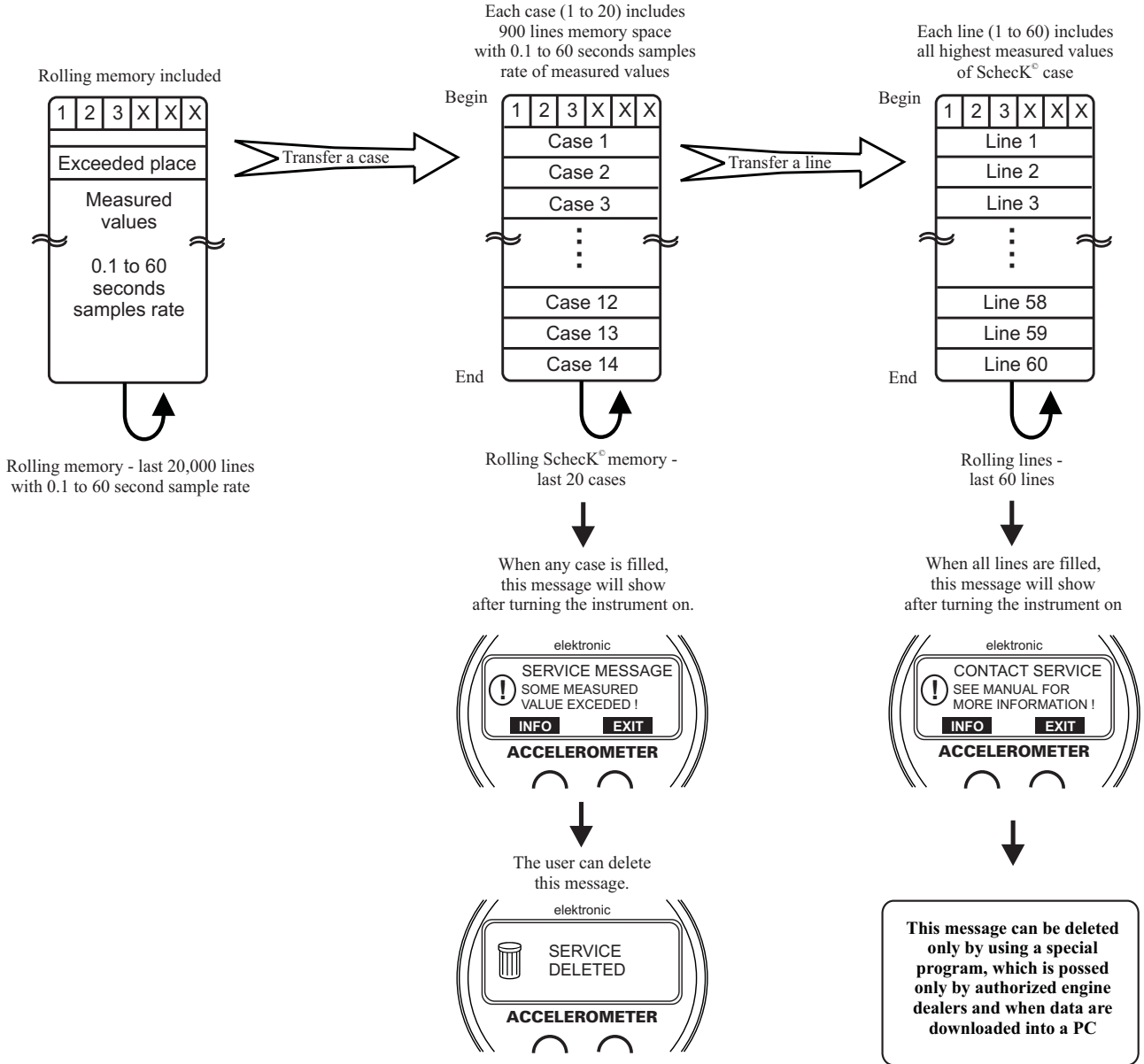

Cases 1 to 20 include 900 lines of exceeded limit values and engine hours when the values were exceeded.

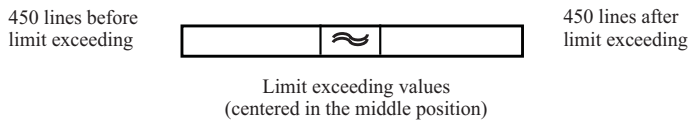

In this version it is possible to read last 20 exceeded records at total operational time.

This page intentionally left blank